

Data Sheet



Article number: 021500700110

Description: Sealing Clamp S 110 W5

Measures

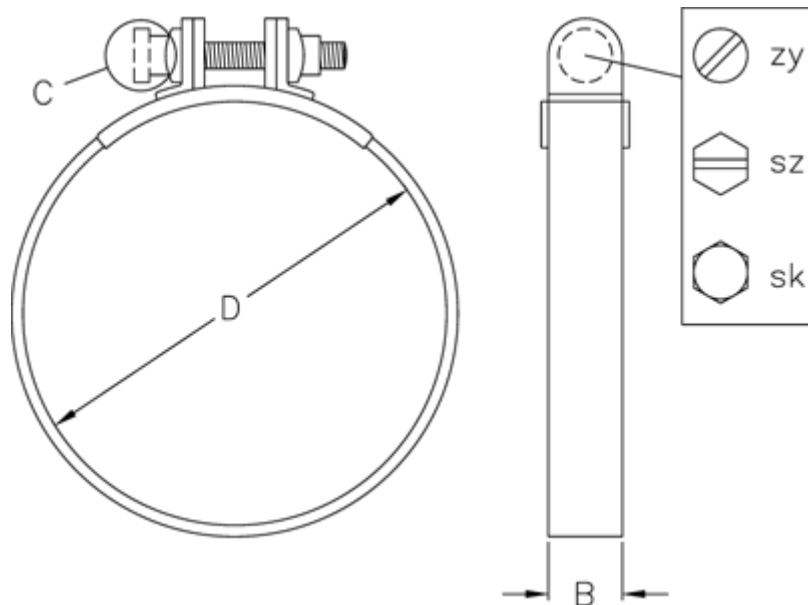

C (screw type) = SZ

Diameter D = 110

Width B = 20